









STARVERT - iS7



Basic Specification







Current Feature

	Frame 1	Frame 2	Frame 3	Frame 4	Frame 5	Frame 6	Frame 7
Main 25 sets							
200V	0.75 1.5 2.2 3.7	5.5 7.5	11 15	18.5 22			
400V	0.75 1.5 2.2 3.7	5.5 7.5	11 15	18.5 22	30 37	45	55 75

Option (Current)

Application Card	<ul style="list-style-type: none"> • PLC • EXT. i/O • Encoder
Network	<ul style="list-style-type: none"> • Profibus
Keypad	<ul style="list-style-type: none"> • Customized Keypad

Future (The end of 2007)

	Frame 8	Frame 9	Frame 10	Frame 11	Frame 12	Frame 13
Main 25 sets						
200V						
400V	90 110	132 160	220	280	315	375

Option (Future)

Network	<ul style="list-style-type: none"> • DeviceNet • LonWork • BacNet • Ethernet
---------	--

Note : Frame for future is not fixed

Basic Specification

EMC Filter, Reactor for small Drive



- EMC Filter : 2 kinds(3.7kW / 7.5kW, 200V/400V)
- Reactor : 12 kinds

EMC Filter, Reactor for Bigger Drive

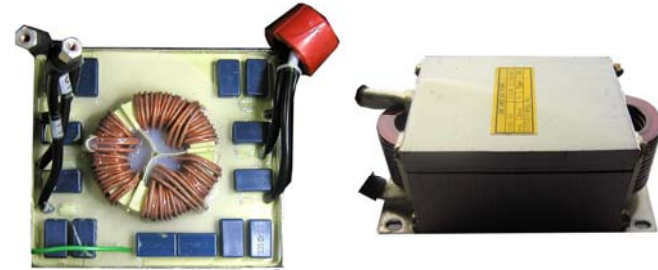

- EMC Filter : 2 kinds (15kW / 22kW, 200V/400V)
- Reactor : 13 kinds

Keypad (Graphic)



- Graphic LCD Keypad: 128x64 COG
- 11 Rubber Key
- 3 LED

Keypad (Customized LCD)



- Customized LCD keypad : 128x64 COG
- 11 Rubber Key
- 3 LED

Specification – 230V series

SV xxx iS7 – 2x			008	015	022	037	055	075
Output Rating	Rated Power [kVA]		1.9	3.0	4.5	6.1	9.1	12.2
	CT (150% 1min)	Motor Rating [Hp]	1	2	3	5	7.5	10
		Rated Current [A]	5	8	12	16	24	32
	VT (110% 1min)	Motor Rating [Hp]	2	3	5	7.5	10	15
		Rated Current [A]	8	12	16	24	32	46
	Output Frequency [Hz]		0 ~ 400 [Hz]					
Output Voltage [V]		3 Phase 200 ~ 230V						
Input Rating	Input Voltage [V]		3 Phase 200 ~ 230 VAC (+10%, -15%)					
	Input Frequency [Hz]		50 ~ 60 [Hz] (±5%)					

SV xxx iS7 – 2x			110	150	185	220
Output Rating	Rated Power [kVA]		17.5	22.9	28.2	33.5
	CT (150% 1min)	Motor Rating [Hp]	15	20	25	30
		Rated Current [A]	46	60	74	88
	VT (110% 1min)	Motor Rating [Hp]	20	25	30	40
		Rated Current [A]	60	74	88	122
	Output Frequency [Hz]		0 ~ 400 [Hz]			
Output Voltage [V]		3 Phase 200 ~ 230V				
Input Rating	Input Voltage [V]		3 Phase 200 ~ 230 VAC (+10%, -15%)			
	Input Frequency [Hz]		50 ~ 60 [Hz] (±5%)			

Specification – 460V series

SV xxx iS7 – 4x		008	015	022	037	055	075	110	150	
Output Rating	Rated Power [kVA]		1.9	3.0	4.5	6.1	9.1	12.2	18.3	22.9
	CT (150% 1min)	Motor Rating [Hp]	1	2	3	5	7.5	10	15	20
		Rated Current [A]	2.5	4	6	8	12	16	24	30
	VT (110% 1min)	Motor Rating [Hp]	2	3	5	7.5	10	15	20	25
		Rated Current [A]	4	6	8	12	16	24	30	39
	Output Frequency [Hz]		0 ~ 400 [Hz]							
Output Voltage [V]		3 Phase 380 ~ 480V								
Input Rating	Input Voltage [V]		3 Phase 380 ~ 480 VAC (+10%, -15%)							
	Input Frequency [Hz]		50 ~ 60 [Hz] (±5%)							

SV xxx iS7 – 4x		185	220	300	370	450	550	750	
Output Rating	Rated Power [kVA]		29.7	34.3	45	56	68	82	100
	CT (150% 1min)	Motor Rating [Hp]	25	30	40	50	60	75	100
		Rated Current [A]	39	45	61	75	91	110	152
	VT (110% 1min)	Motor Rating [Hp]	30	40	50	60	75	100	125
		Rated Current [A]	45	61	75	91	110	152	183
	Output Frequency [Hz]		0 ~ 400 [Hz]						
Output Voltage [V]		3 Phase 380 ~ 480V							
Input Rating	Input Voltage [V]		3 Phase 380 ~ 480 VAC (+10%, -15%)						
	Input Frequency [Hz]		50 ~ 60 [Hz] (±5%)						

System Block

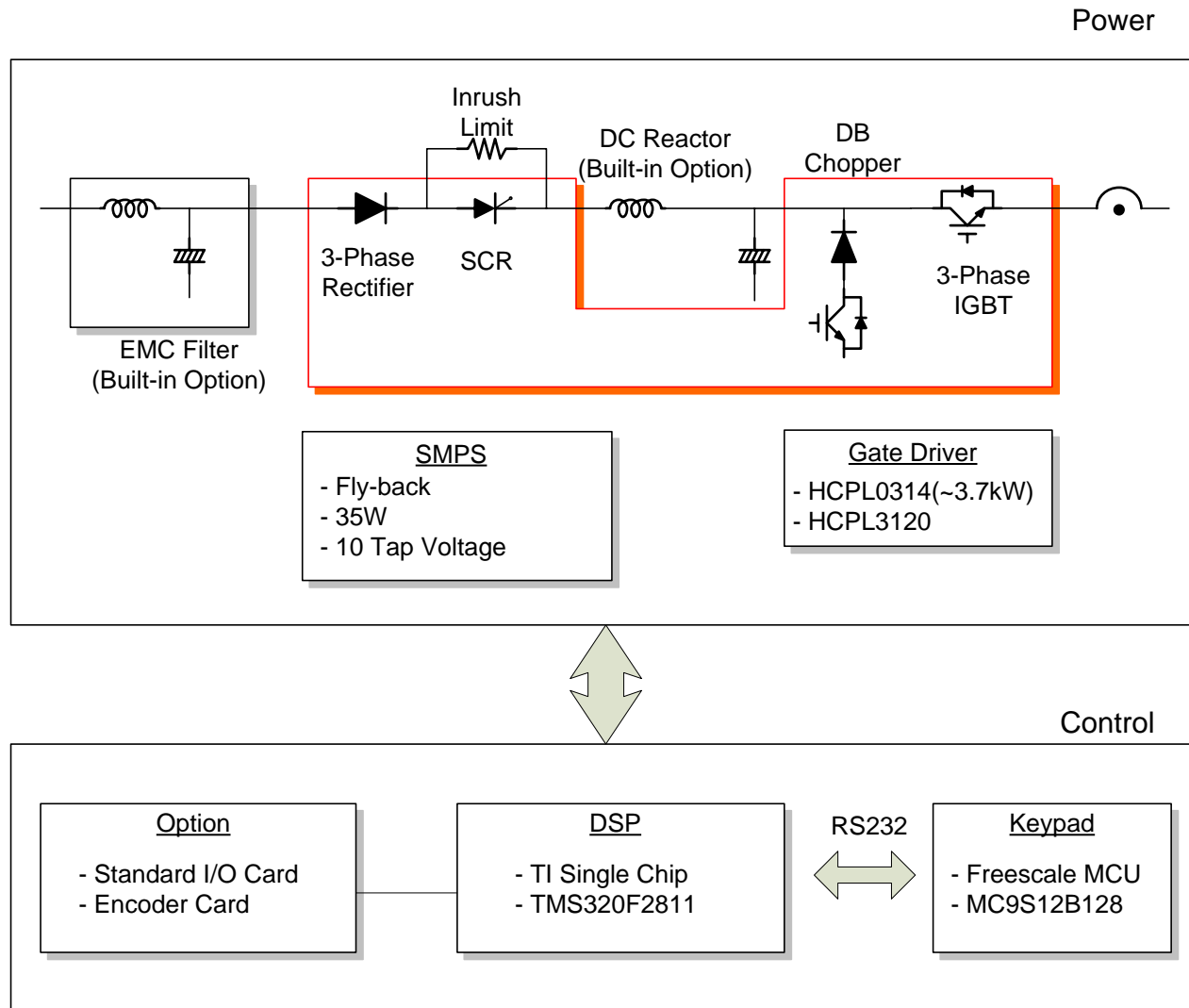

Standard I/O Card – compare to other drives

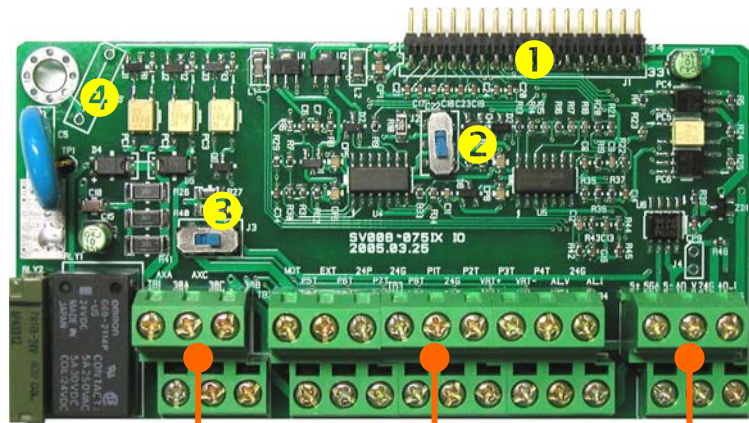

- ❶ : Control Card
- ❷ : SW for I/ PTC
- ❸ : NPN/PNP
- ❹ : Earth

- Relay output
- DI/DO
- AI
- RS485
- AO

		iS7	iS5	iP5A
Input	Programmable DI	8	8	8
	NPN/PNP	0	X	0
	Analog V input	-10 ~ +10V	0~+10V	-10 ~ +10V
	Analog I input	0 ~ 20mA	0 ~ 20mA	0 ~ 20mA
	Pulse Train	Option	Option	~100kHz
Output	Programmable relay	2	2	5
	Programmable OC	1	-	-
	AO1	0 ~ 10V	0 ~ 10V	0 ~ 10V
	AO2	0 ~ 20mA	-	0 ~ 20mA(37kW~)
Built-in Comm.	RS485	0	X	0

Option – Extension I/O Card

- **Specification**

- Communication to main board by SPI
- Serial A/D Converter :
 - 2 Channel 12 bits
- Serial D/A Converter :
 - 2 Channel 12 bit
- DC-DC Converter for signal isolation

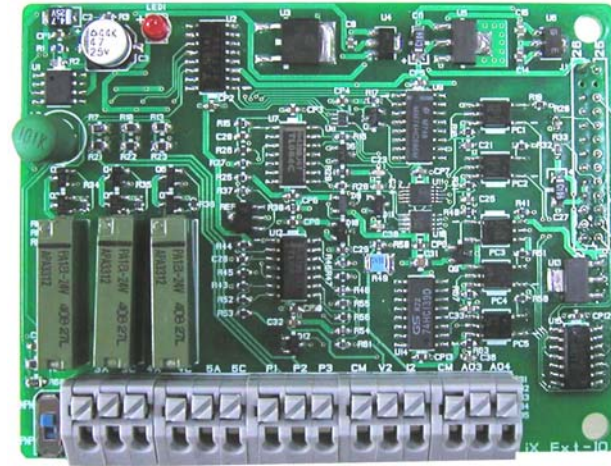

- **Input/Output specification**

Input	Digital Input	<ul style="list-style-type: none">• Programmable digital input 3sets• NPN/PNP Selectable
	Analog Input	<ul style="list-style-type: none">• Voltage : -10 ~ +10V (11 bits)• Current : 0 ~ 20mA (12 bits)
Output	Digital Output	<ul style="list-style-type: none">• Programmable Digital Relay 3 sets• 250VAC/30VDC, 5A, Normal Open
	Analog Output	<ul style="list-style-type: none">• Voltage : -10 ~ +10V (11 bits)• Current : 0 ~ 20mA (12 bits)

Option – PLC

- **Hardware Specification**
 - Platform : Master-K120S
 - Input : 6 DI (Sink/Source Selectable)
 - Output : 4 DO (N.O. Relay)
 - Built-in Communication
 - Modbus-RTU
 - RTC Function
- **Main feature**
 - User Program – KGL Win
 - Program Size : 2000 Steps

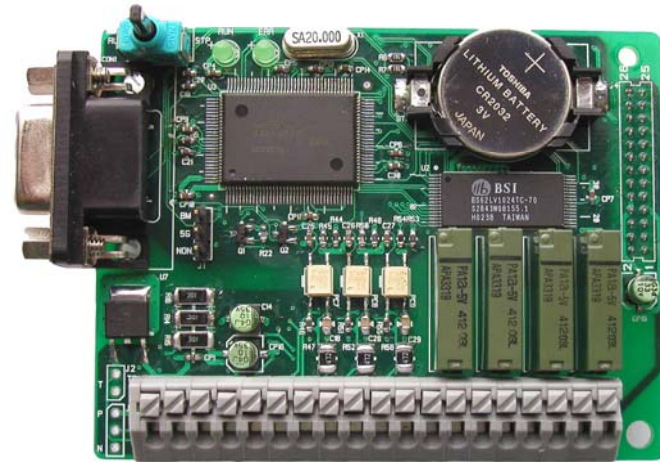

Note 1) Digital Input extension : This option can access DI on main drive Total 14

Note 2) Digital Output extension : This option can access DO on main drive Total 7

Optional Encoder Card for closed loop control and reference



- ❶ : DC-DC Converter
- ❷ : Control Card
- ❸ : Line Drive / O.C.
- ❹ : Encoder Signal

• Card Specification

	iS7	iS5	iP5A
Output Voltage	5/12/15V	-	12V
Isolation	0	0	X
Type	Line Drive / O.C.	Line Drive / O.C.	O.C.
Repeater	0	0	-
Max.Freq	200kHz	100kHz	100kHz
Wire cut Check	0	-	-

DC Reactor



- Specification

Overload	110% (VT Rating)
THD	28 ~ 37%
Power factor	94 ~ 96%
IP Level	IP21
Insulation Class	F Class(155°C)

- 3.7kW/200V Input current and THD

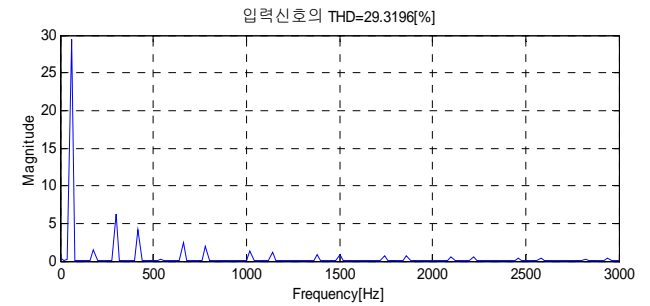
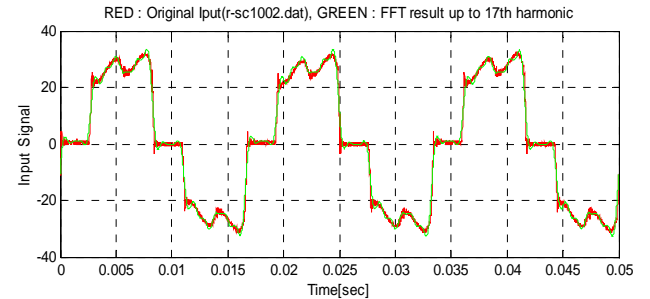

- THD : 29.3%

- PF : 95.9%

EMC Filter

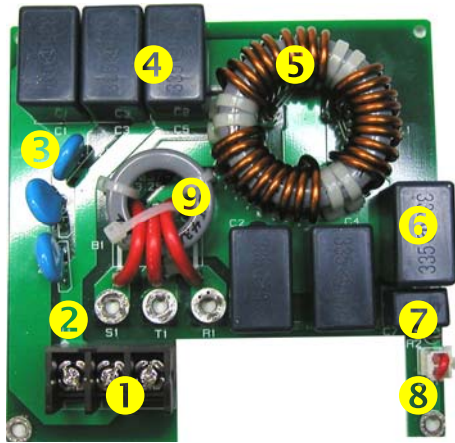

- ❶ : RST-1
- ❷ : RST-2
- ❸ : MOV
- ❹ : Cx1
- ❺ : L1
- ❻ : Cx2
- ❼ : Cy
- ❽ : SW
- ❾ : L2

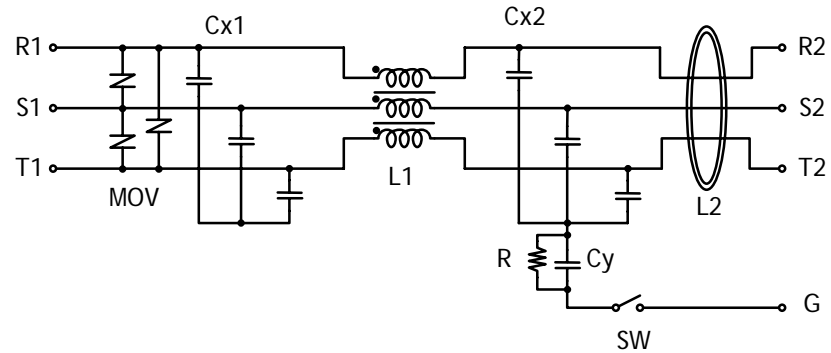

•Specification

- Compliance : 1st Environment, Restricted Distribution(EN61800-3)
- Semi-2 Step Topology
- Ferrite Choke & Bead
- SW for IT Networks (Floating Networks)

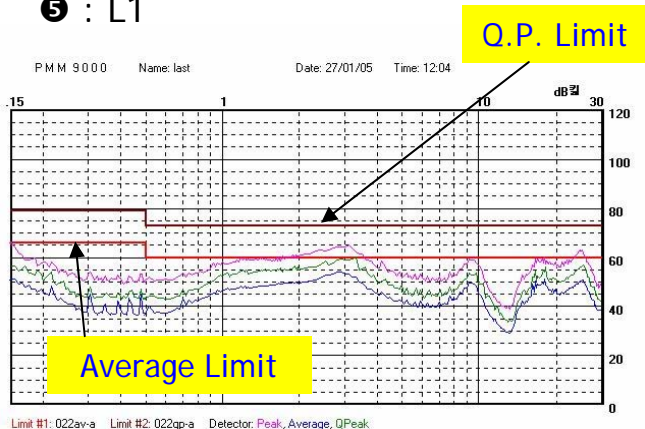

Red:Peak, Green:Quasi-Peak, Blue:Average

•Conducted Emission Limits Margin

		3.7kW	7.5kW	15kW	22kW
200V	Quasi-Peak	13db	11db	15db	12db
	Average	5db	3db	6db	3db
400V	Quasi-Peak	11db	15db	10db	10db
	Average	5db	7db	6db	3db

Keypad

Graphic LCD



- Graphic LCD
 - 128 x 64 Pixel
 - Size : 65 x 43.5 x 4.8
- Specification
 - 128k Flash, 4k RAM
 - 16k x 6 bank : Multi Language(6)



Customized LCD

- HTN LCD
- Customized BackLight Module
- English Only

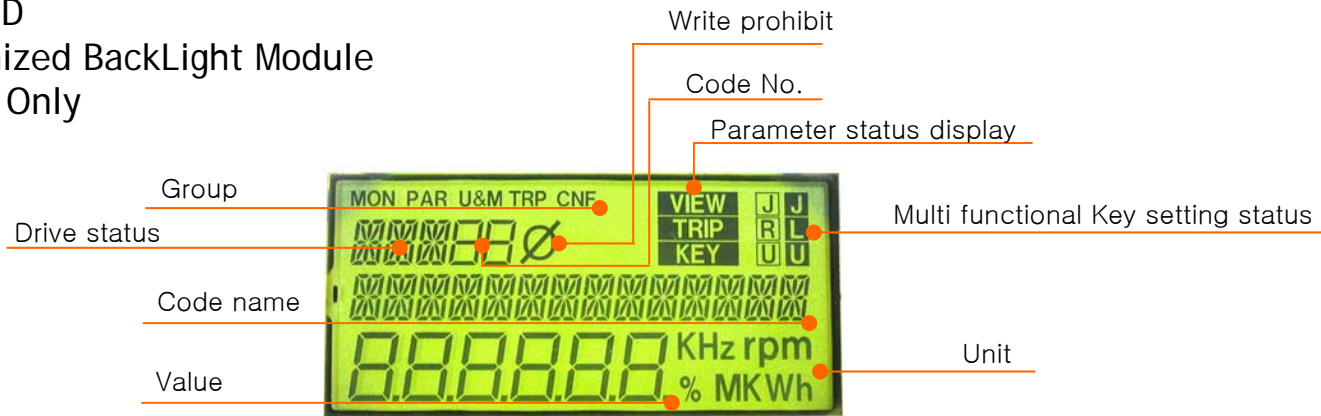

Keypad Display

• Monitor Mode

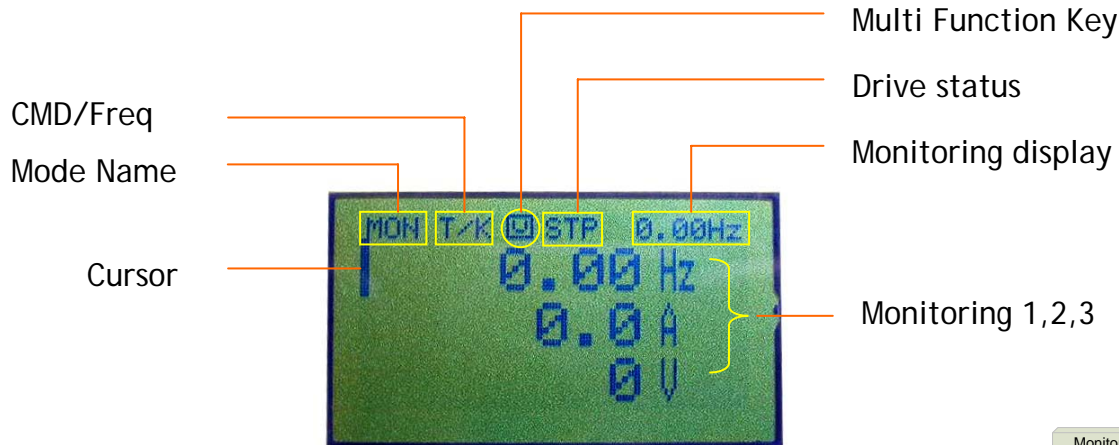

• Mode shift

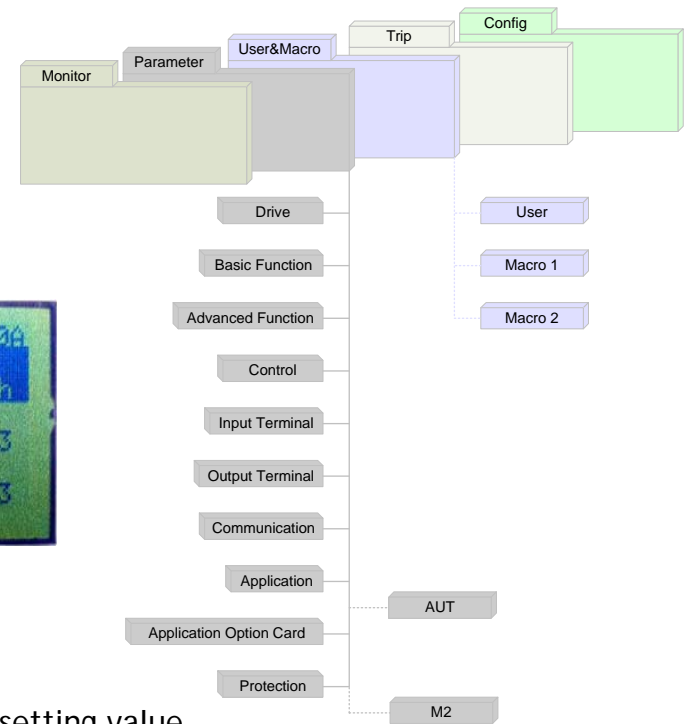
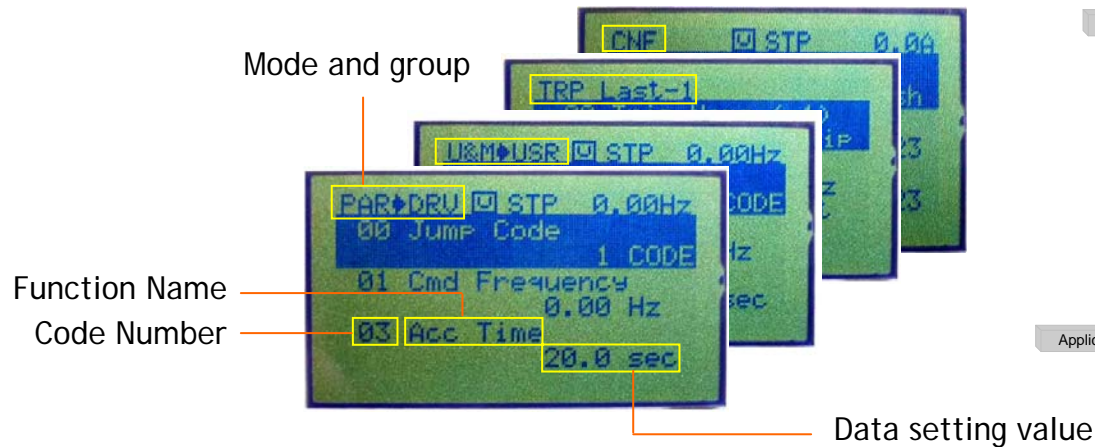

Keypad Display

- Parameter Edit

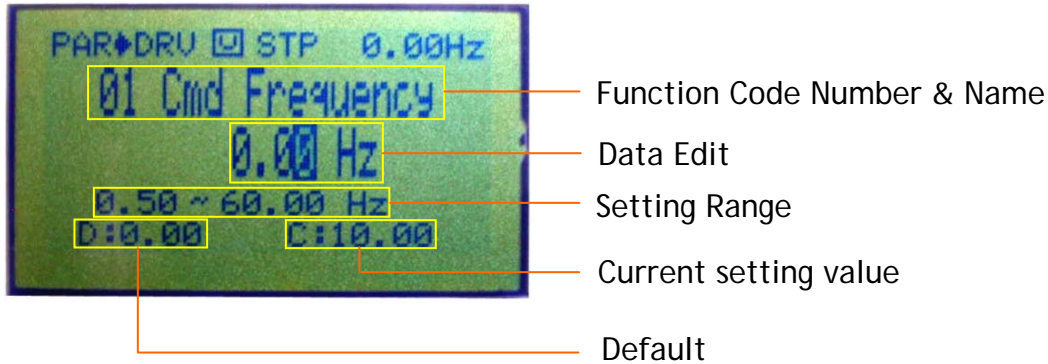

- Trip Display

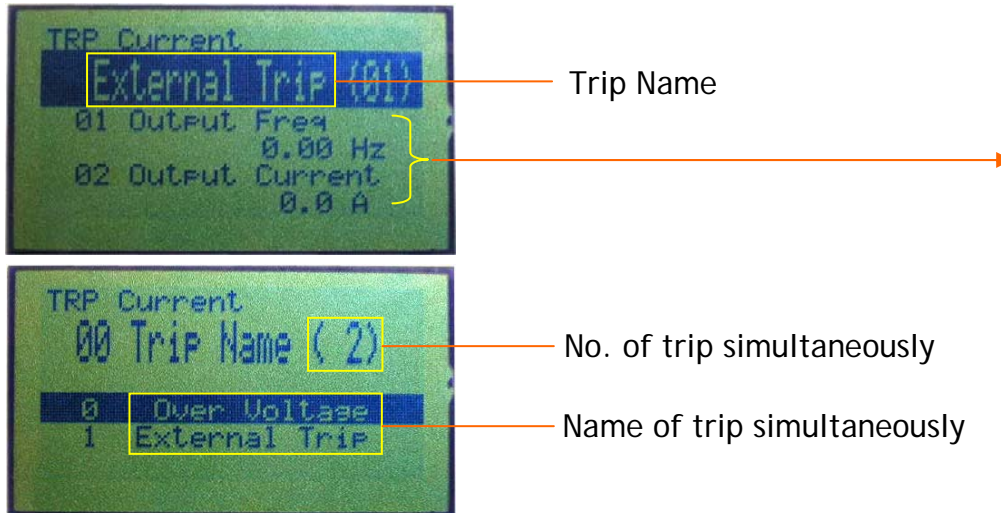

01	Output Freq
02	Output Current
03	Inverter State
04	DC Link Voltage
05	Input State
06	Output State
07	Trip Time

Parameter Tree

- 5 Mode & 15 Parameter Group

Monitor	- Drive status Monitoring - Reference Set (Frequency, PID, Torque)
Parameter	- 12 Group
User & Macro	- 3 Group : User Parameter and Macro
Trip	- Current and past trip Monitor
Configuration	- Parameter setting and Parameter Copy

- User Parameter by Multi-Function Key
- Application Macro : Draw, Traverse...
- Parameter Mode Hidden
- Group by meaning : AUT, M2, User, Macro1 & 2
- iS5 Parameter Tree
 - 7 Mode : DRV / FU1 / FU2 / IO / EXT / COM / APP

